

• IDENTIFICAZIONE •



IDENTIFICAZIONE



Conf.

Codice

MARCHE DALLASFLEX

(NON NUMERATE)

1	ROTONDO MASCHIO	∅ mm	3	100 Pz.	A10000
2	ROTONDO FEMMINA	∅ mm	2,9	100 Pz.	A10007
3	PICCOLO MASCHIO	mm	4,1x2,3	100 Pz.	A10014
4	PICCOLO FEMMINA	mm	4,1x2,3	100 Pz.	A10021
5	LARGE MASCHIO	mm	5,7x3,7	100 Pz.	A10028
6	LARGE FEMMINA	mm	6,2x4,2	100 Pz.	A10035
7	MAXI FEMMINA	mm	7,5x5,3	100 Pz.	A10042
8	STRISCIA MASCHIO	mm	4,8x1,9	100 Pz.	A10049
9	STRISCIA FEMMINA	mm	4,8x1,9	100 Pz.	A10056
10	STRISCIA INTERA	mm	9,6x1,9	100 Pz.	A10063

Su richiesta si possono numerare e/o siglare

COLORI DISPONIBILI:

Bianca/Arancia/Giallo/Verde/Blu/Rosso



MARCHE ALLFLEX

(NON NUMERATE)

ROTONDO MASCHIO	100 Pz.	A10100
ROTONDO FEMMINA	100 Pz.	A10107
PICCOLO MASCHIO	100 Pz.	A10114
PICCOLO FEMMINA	100 Pz.	A10121
LARGE MASCHIO	100 Pz.	A10128
LARGE FEMMINA	100 Pz.	A10135
MAXI FEMMINA	100 Pz.	A10142

Su richiesta si possono numerare e/o siglare



COLORI DISPONIBILI:

Bianco/Arancio/Giallo/Verde/Rosso/Azzurro

Scala 1:1

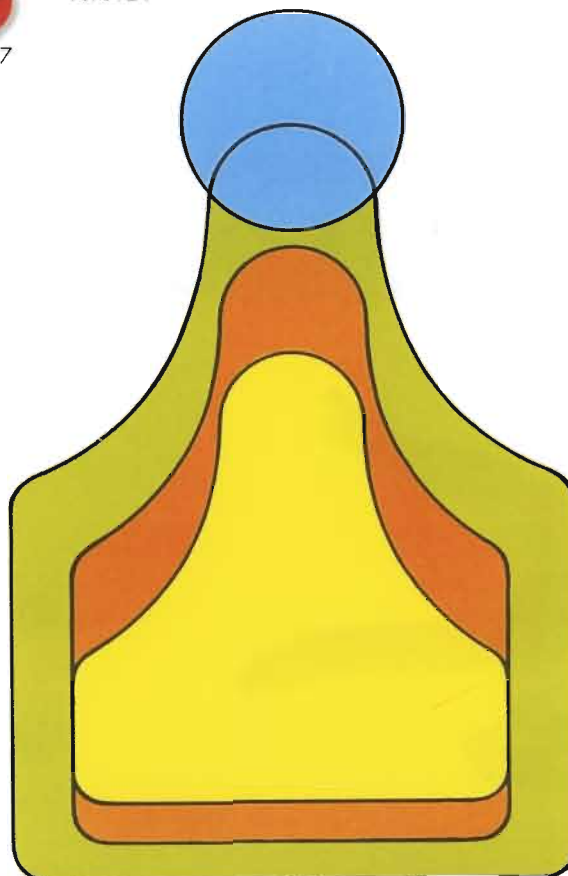



Codice

Conf.

MARCHE CAMI

(NON NUMERATE)

A10200

100 Coppie

PICCOLA PER SUINI

A10210

100 Coppie

GRANDE PER BOVINI

COLORI DISPONIBILI:
Giallo/Bianco

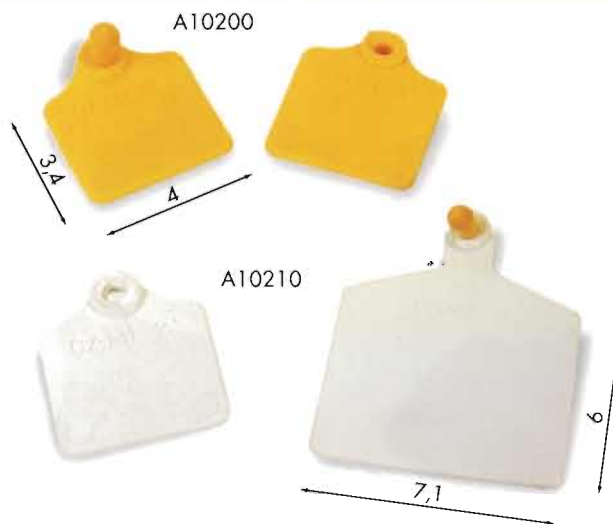

MARCHE ARDES

(NON NUMERATE)

A10220

50 Pz.

1 MAXI FEMMINA

A10226

50 Pz.

2 LARGE FEMMINA

A10232

50 Pz.

3 LARGE MASCHIO (PUNTA METALLO)

A10238

50 Pz.

4 MEDIA FEMMINA

A10244

50 Pz.

5 MEDIA MASCHIO

A10250

50 Pz.

6 PICCOLA FEMMINA

A10256

50 Pz.

7 PICCOLA MASCHIO (PUNTA METALLO)

A10298

50 Pz.

8 PICCOLA MASCHIO (PUNTA PLASTICA)

A10262

50 Coppie

9 MINITAGS

A10268

50 Pz.

10 ROTONDO FEMMINA

A10274

50 Pz.

11 ROTONDO MASCHIO (PUNTA PLASTICA)

A10280

50 Pz.

12 ROTONDO MASCHIO (PUNTA METALLO)

A10286

50 Pz.

13 ROTONDO MINI MASCHIO (PUNTA METALLO)

A10292

50 Coppie

14 A STRISCIA OVITAGES



ROTONDO



ROTONDO
MINI

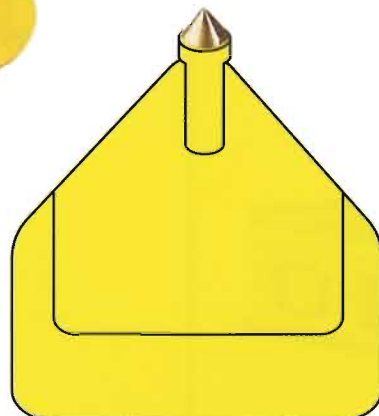

SCALA 1:1

COLORI DISPONIBILI:
Giallo/Bianco/Azzurro/Verde/Rosso

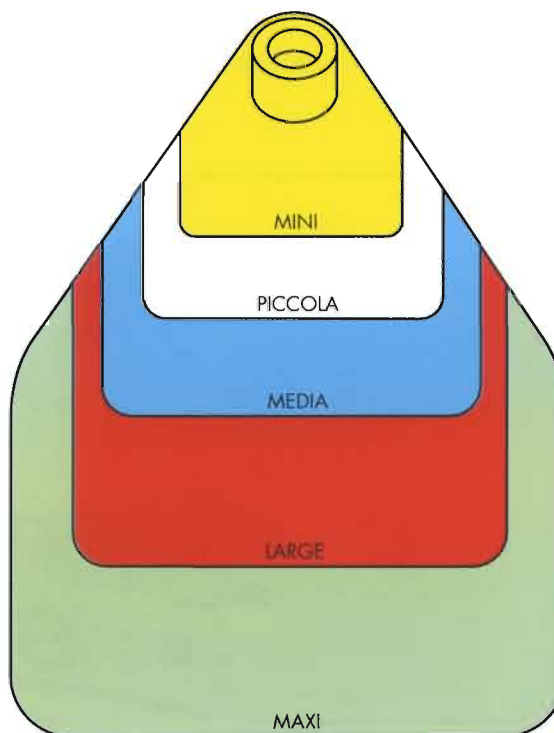



MARCHE CHEVILLOT (NON NUMERATE)

LARGE FEMMINA
LARGE MASCHIO

1 Pz. A10310
1 Pz. A10311

Su richiesta si possono numerare e/o siglare
COLORI DISPONIBILI:
Giallo/Arancio

MARCHE DEMAFLEX (NON NUMERATE)

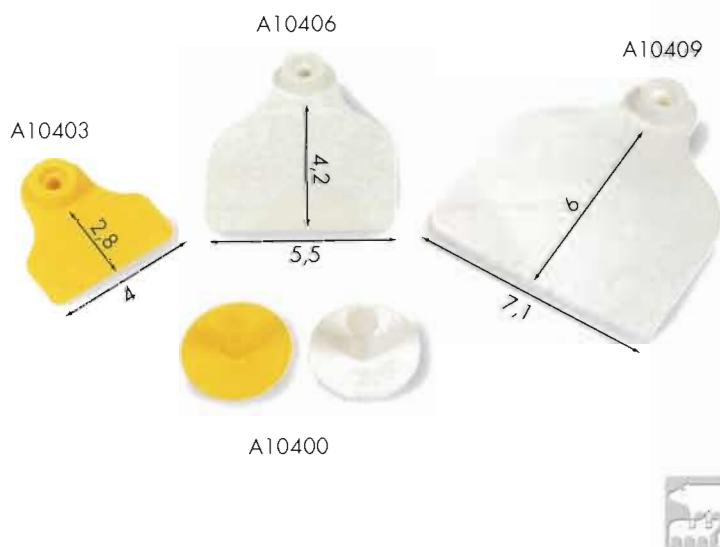

ROTONDO MASCHIO
PICCOLO FEMMINA
LARGE FEMMINA
MAXI FEMMINA

50 Pz. A10400
50 Pz. A10403
50 Pz. A10406
50 Pz. A10409

Su richiesta si possono numerare e/o siglare
COLORI DISPONIBILI:
Giallo/Bianco

MARCHE DURAFIX



NUMERATA
NON NUMERATA
COLORI DISPONIBILI:
Giallo/Bianco

100 Pz. A10500
100 Pz. A10510



Codice

Conf.

A10710

1 Coppia

MARCHE MININEOFLEX (NON NUMERATE)

MARCHE MININEOFLEX

Su richiesta si possono numerare e/o siglare

COLORI DISPONIBILI:
Giallo



A10800

100 Pz.

MARCHE PER CONIGLI IN PLASTICA

NUMERATA

COLORI DISPONIBILI:
Bianco/Blu/Giallo/Rosso/Verde

A10810

100 Pz.

NON NUMERATA

COLORI DISPONIBILI:
Giallo



A10800



A10850

100 Pz.

MARCHE PER CAVIA IN METALLO

NUMERATA



A10850



IDENTIFICAZIONE



Conf.

Codice

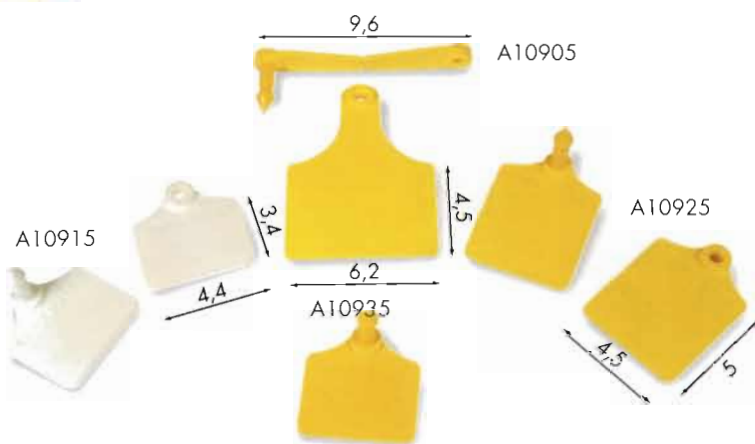

MARCHE PRIMAFLEX

0 A STRISCIA NUMERATA
0 A STRISCIA NON NUMERATA

25 Coppie A10900
25 Coppie A10905

COLORI: Bianco/Giallo/Verde/Azzurro

1 PICCOLA NUMERATA
1 PICCOLA NON NUMERATA *

25 Coppie A10910
25 Coppie A10915

COLORI: Bianco/Giallo/Verde

2 LARGE NUMERATA
2 LARGE NON NUMERATA

25 Coppie A10920
25 Coppie A10925

COLORI: Bianco/Giallo

3 MAXI NUMERATA
3 MAXI NON NUMERATA

25 Coppie A10930
25 Coppie A10935

COLORI: Bianco/Giallo



MARCHE SUPERCROTAL

PER BOVINI

NICHELATA NON NUMERATA
NICHELATA NUMERATA
OTTONATA NON NUMERATA
OTTONATA NUMERATA

100 Pz. A11000
100 Pz. A11001
100 Pz. A11002
100 Pz. A11003

PER OVINI

NICHELATA NON NUMERATA
NICHELATA NUMERATA
OTTONATA NON NUMERATA
OTTONATA NUMERATA

100 Pz. A11010
100 Pz. A11011
100 Pz. A11012
100 Pz. A11013

PUNZONE

SERIE LETTERE
SERIE NUMERI
INCUDINE

27 Pz. A11060
9 Pz. A11061
1 Pz. A11062

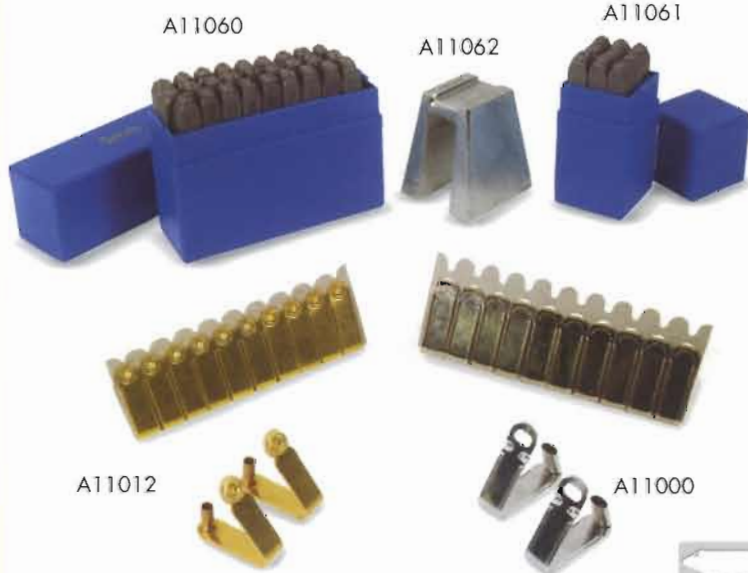

MARCHE VIS 6

NUMERATA LASER Ø cm. 2,8

50 Coppie A11150

PANTOGRAFATA Ø cm. 2,8

25 Coppie A11160

COLORI DISPONIBILI:
Blu/Arancio/Giallo/Bianco/Rosso/Verde





Codice

Conf.

MARCHE CANADIAN (NON NUMERATE)

A11200

50 Pz.

GRANDE

A11210

50 Pz.

PICCOLA

COLORI DISPONIBILI:
Arancio/Blu/Rosso/Bianco/Verde/Giallo

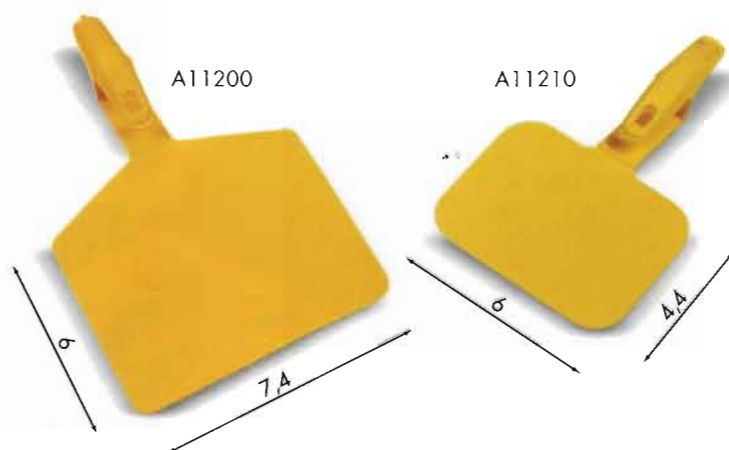

MARCHE MINISTERIALI

A11300

1 Pz.

MARCA MINISTERIALE

A11340

1 Pz.

CEDOLINO STAMPATO

A11350

1 Pz.

CEDOLINO NON STAMPATO

A11360

1 Pz.

PASSAPORTO



PENNARELLI INDELEBILI PER MARCHE

A11420

1 Pz.

ALLFLEX

A11430

1 Pz.

ARDES

A11420



A11430





LAVAGNETTA PLASTICA

LAVAGNETTA PLASTICA

1 Pz.

A11600

ATTACCHI PER LAVAGNETTA

PICCOLO Ø 35 mm

1 Pz.

A11610

MEDIO Ø 40 mm

1 Pz.

A11611

GRANDE Ø 45 mm

1 Pz.

A11612

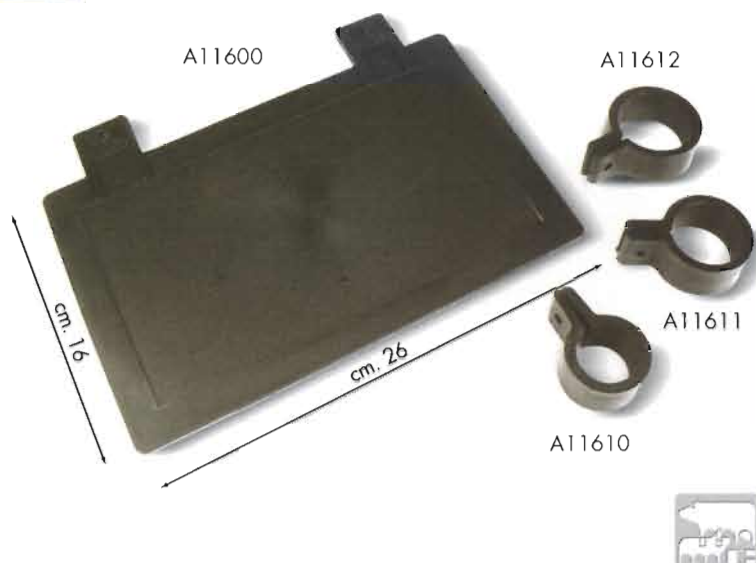

TENAGLIE APPLICAZIONE MARCHE

ALLFLEX

1 Pz.

A11700

Plastica Nera

1 Pz.

A1170A

AGO ALLFLEX

1 Pz.

A11900

AGO MININEOFLEX

1 Pz.

A11920

DADO UNIVERSALE PER AGO PER TENAGLIA

1 Pz.

A12000

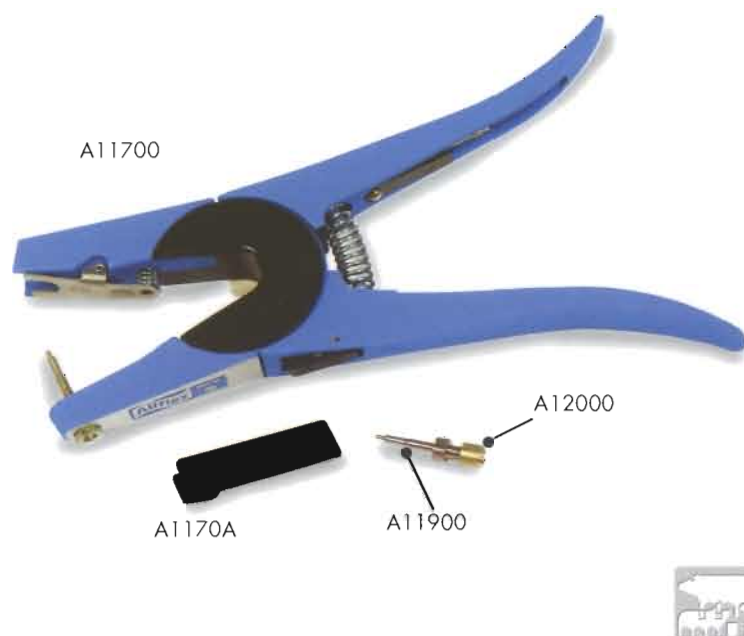

TENAGLIE APPLICAZIONE MARCHE

CUSI

1 Pz.

A11720

Kit Completo Ricambio

1 Pz.

A1172A





Codice	Conf.	
TENAGLIE APPLICAZIONE MARCHE		
A11730	1 Pz.	DALLASFLEX
A1173A	1 Pz.	<i>Molla Manico</i>
A1173B	1 Pz.	<i>Piastrina</i>
A11750	1 Pz.	MINI NEOFLEX
A11910	1 Pz.	AGO DALLAS CON PUNTA
A11911	1 Pz.	AGO DALLAS SENZA PUNTA
A12000	1 Pz.	DADO UNIVERSALE



Codice	Conf.	
TENAGLIE APPLICAZIONE MARCHE		
A11740	1 Pz.	DEMAFLEX
A1174A	1 Pz.	<i>Blocco Porta Marca</i>



Codice	Conf.	
TENAGLIE APPLICAZIONE MARCHE		
A11760	1 Pz.	PRIMAFLEX
A1176A	1 Pz.	<i>Set Molle e Plastica</i>
A1176C	2 Pz.	<i>Piastrine Ricambio In Ferro</i>
A11770	1 Pz.	PRIMAFLEX PER ALLFLEX
A1176A	1 Pz.	<i>Set Molle e Plastica</i>
A1176C	2 Pz.	<i>Piastrine Ricambio In Ferro</i>
A1177A	1 Pz.	<i>Bussola Adattamento Aghi</i>
A11930	1 Pz.	SET AGO PRIMAFLEX PER ALLFLEX
A11910	1 Pz.	AGO DALLAS CON PUNTA
A11911	1 Pz.	AGO DALLAS SENZA PUNTA
A11940	1 Pz.	AGO STRONG TAG [ALLFLEX,MININEOFLEX.....]





A11780

TENAGLIE APPLICAZIONE MARCHE

SUPERCROTAL PER OVINI

1 Pz.

A11780

SUPERCROTAL PER BOVINI

1 Pz.

A11781



A11795

TENAGLIE APPLICAZIONE MARCHE

VIS 6

1 Pz.

A11795



TENAGLIE APPLICAZIONE MARCHE

ARDES

1 Pz.

A11800

AGO ARDES

1 Pz.

A11960



A11800



A11960





Codice

Conf.

AGHI PER TENAGLIA

- A11900 1 Pz. ALLFLEX
- A11910 1 Pz. DALLAS CON PUNTA
- A11911 1 Pz. DALLAS SENZA PUNTA
- A11920 1 Pz. MININEOFLEX
- A11930 1 Pz. SET PRIMAFLEX PER ALLFLEX
- A11940 1 Pz. STRONG TAG (SPAGNOLO)
- A11950 1 Pz. AGO CHEVILLOT
- A11960 1 Pz. ARDES



PASTA TATUAGGIO

- A20000 1 Pz. HAUPTNER 60g. COLORE NERO
- A20003 1 Pz. HAUPTNER 600g. COLORE NERO
- A20005 1 Pz. HAUPTNER 60g. COLORE VERDE
- A20008 1 Pz. HAUPTNER 600g. COLORE VERDE
- A20010 1 Pz. RAIDEX 60g. COLORE NERO
- A20013 1 Pz. RAIDEX 600g. COLORE NERO
- A20015 1 Pz. RAIDEX 60g. COLORE VERDE
- A20018 1 Pz. RAIDEX 600g. COLORE VERDE

ROLL BALL

- A21000 1 Pz. HAUPTNER COLORE NERO
- A21010 1 Pz. RAIDEX COLORE NERO
- A21020 1 Pz. TEDESCO COLORE BIANCO
- A21021 1 Pz. TEDESCO COLORE VERDE



SIRE SIGNE

- A22000 1 Pz. CINGHIA SIRE SIGNE IN CUOIO
- A22010 1 Pz. CINGHIA SIRE SIGNE IN NYLON
- A22100 1 Pz. TAMPONE

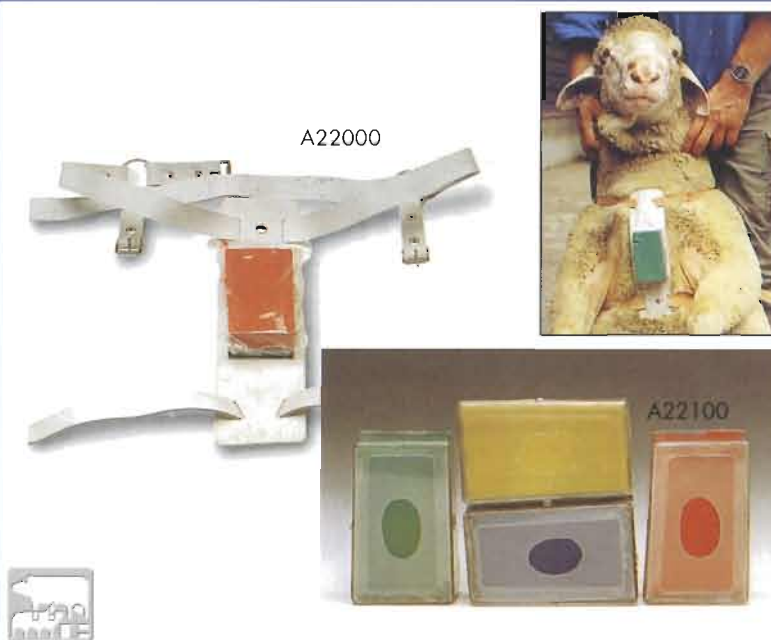



A23000



MATITA PER CARNI

12 Pz.

A23000



A24000

A24010

A24020



INCHIOSTRO SPRAY PER TATUAGGIO SUINI

NEGHER colore nero

1 Pz.

A24000

PECKER colore nero

1 Pz.

A24010

RAIDEX colore nero

1 Pz.

A24020



A24130

A24110

A24120

A24100

A24200

INCHIOSTRI PER TATUAGGIO

HAUPTNER ml 250 colore verde

1 Pz.

A24100

HAUPTNER L1 colore viola

1 Pz.

A24110

RAIDEX ml 250 colore nero

1 Pz.

A24120

RAIDEX L1 colore nero

1 Pz.

A24130

PER CARNI

COLORI DISPONIBILI:

Rosso Allura/Blu Brillante/Marrone

1 Pz.

A24200



A24320



A24300



A24310



A24301



PER DERMOGRAFO

100 g colore nero

1 Pz.

A24300

100 g colore verde

1 Pz.

A24301

125 g colore verde

1 Pz.

A24310

250 g colore nero

1 Pz.

A24320

250 g colore verde

1 Pz.

A24321



Codice Conf.

DERMOGRAFO GENIA

- | | | |
|--------|-------|-----------------------|
| A25000 | 1 Pz. | DERMOGRAFO GENIA |
| A2500A | 1 Pz. | Ago Singolo |
| A2500B | 1 Pz. | Ago Multiplo |
| A2500C | 1 Pz. | Albero a Camme |
| A2500D | 1 Pz. | Asta Contatto |
| A2500E | 1 Pz. | Chiave Svita Ago |
| A2500F | 1 Pz. | Corpo |
| A2500G | 1 Pz. | Gomma Intermedia Ago |
| A2500H | 1 Pz. | Guaina Albero a Camme |
| A2500L | 1 Pz. | Guaina Protezione Ago |
| A2500M | 1 Pz. | Molla Albero a Camme |
| A2500N | 1 Pz. | Motore |
| A2500P | 1 Pz. | Sieger Motore |
| A2500Q | 1 Pz. | Port'Ago |
| A2500R | 1 Pz. | Puntale Ago |
| A2500S | 1 Pz. | Sieger Albero a Camme |
| A2500T | 1 Pz. | Trasformatore |
| A2500U | 1 Pz. | Vite Asta Contatto |



DERMOGRAFO TEDESCO

- | | | |
|--------|-------|--------------------------|
| A25100 | 1 Pz. | DERMOGRAFO TEDESCO |
| A2510A | 1 Pz. | Ago |
| A2510B | 1 Pz. | Albero a camme |
| A2510C | 1 Pz. | Eccentrico |
| A2510D | 1 Pz. | Gomma intermedia |
| A2510E | 1 Pz. | Gomma per inchiostro |
| A2510F | 1 Pz. | Guaina protezione ago |
| A2510G | 1 Pz. | Guarnizione puntale |
| A2510H | 1 Pz. | Molla spingi motore |
| A2510L | 1 Pz. | Motore |
| A2510M | 1 Pz. | Pedana |
| A2510N | 1 Pz. | Puntale |
| A2510P | 1 Pz. | Sieger motore |
| A2510Q | 1 Pz. | Tappo inferiore |
| A2510R | 1 Pz. | Tappo piccolo posteriore |
| A2510S | 1 Pz. | Tappo superiore |
| A2510T | 1 Pz. | Trasformatore |

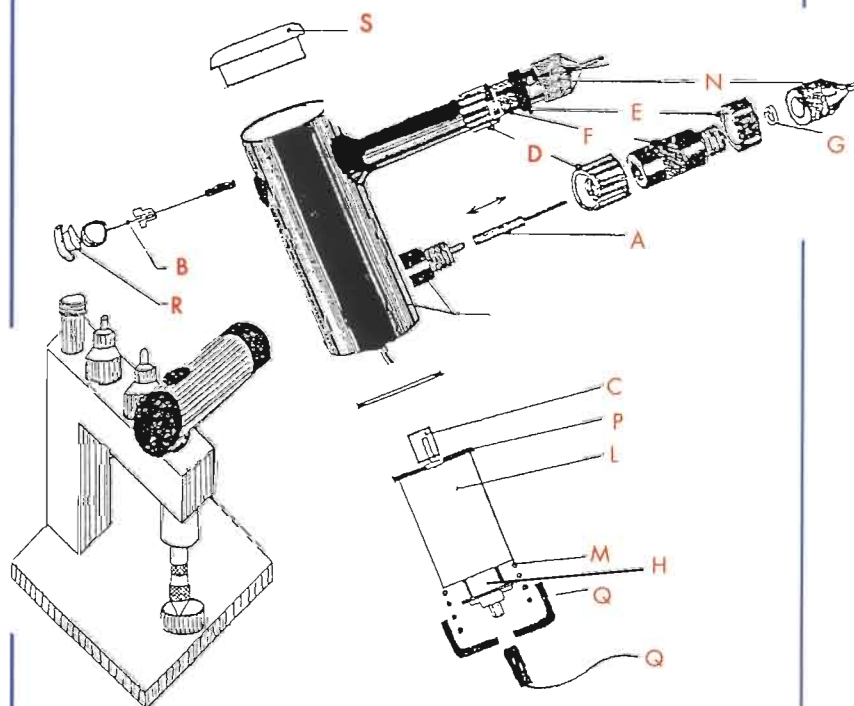

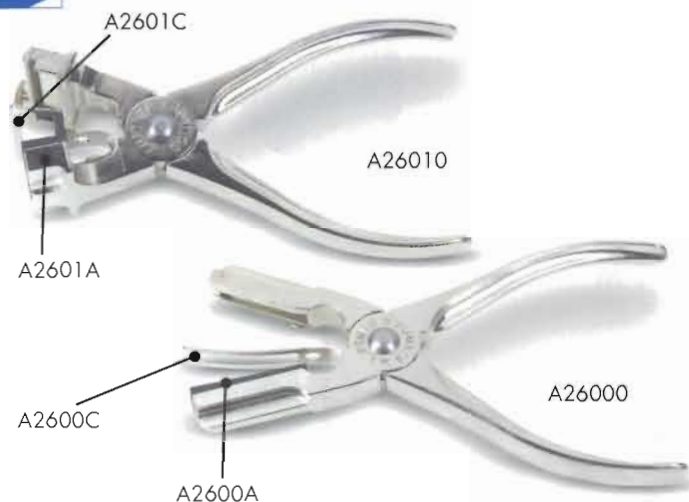

TENAGLIE TATUAGGIO

HAUPTNER 5 mm 7 SPAZI trasversale

1 Pz.

A26000

Gomma

1 Pz.

A2600A

Molla manico

1 Pz.

A2600B

Piastrina divisoria

1 Pz.

A2600C

HAUPTNER 7 mm 7 SPAZI su una fila

1 Pz.

A26010

Gomma

1 Pz.

A2601A

Molla manico

1 Pz.

A2601B

Piastrina divisoria

1 Pz.

A2601C



TENAGLIE TATUAGGIO

HAUPTNER 10 mm 5 SPAZI su una fila

1 Pz.

A26020

Gomma

1 Pz.

A2602A

HAUPTNER 10 mm 7 SPAZI su una fila

1 Pz.

A26030

Gomma

1 Pz.

A2603A



TENAGLIE TATUAGGIO

HAUPTNER 10 mm 10 SPAZI su due file

1 Pz.

A26040

Gomma

1 Pz.

A2604A

HAUPTNER 10 mm 12 SPAZI su due file

1 Pz.

A26050

Gomma

1 Pz.

A2605A

NAZIONALE 10 mm 10 SPAZI su due file

1 Pz.

A26240

Gomma

1 Pz.

A2624A

Molla Manico

1 Pz.

A2624B

Vite Manico

1 Pz.

A2624C

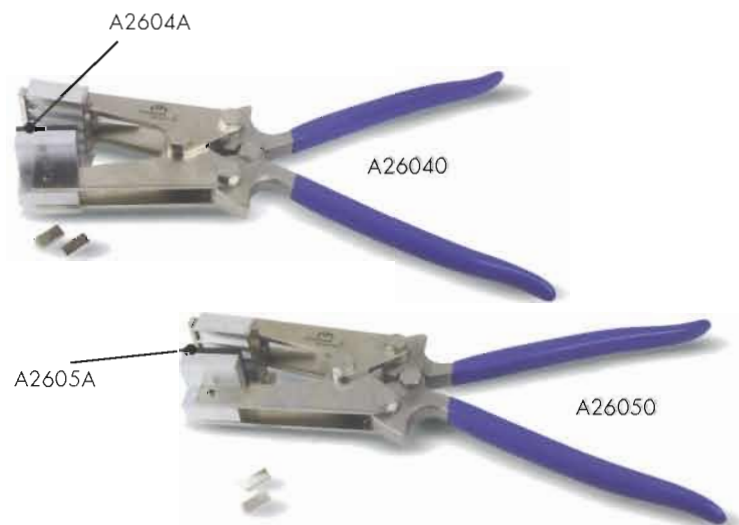



Codice

Conf.

TENAGLIE TATUAGGIO

A26060	1 Pz.	HAUPTNER 15 mm 5 SPAZI su una fila
A26070	1 Pz.	HAUPTNER 20 mm 5 SPAZI su una fila



A26060



TENAGLIE TATUAGGIO

A26100	1 Pz.	HORSTMANN AUTOMATICA
A2689A/Z	1 Pz.	LETTERE HORSTMANN
A26900/9	1 Pz.	NUMERI HORSTMANN
A26910	1 Pz.	SPAZIATORE HORSTMANN
A26911	26 Pz.	SERIE LETTERE COMPLETA HORSTMANN
A26912	10 Pz.	SERIE NUMERI COMPLETA HORSTMANN

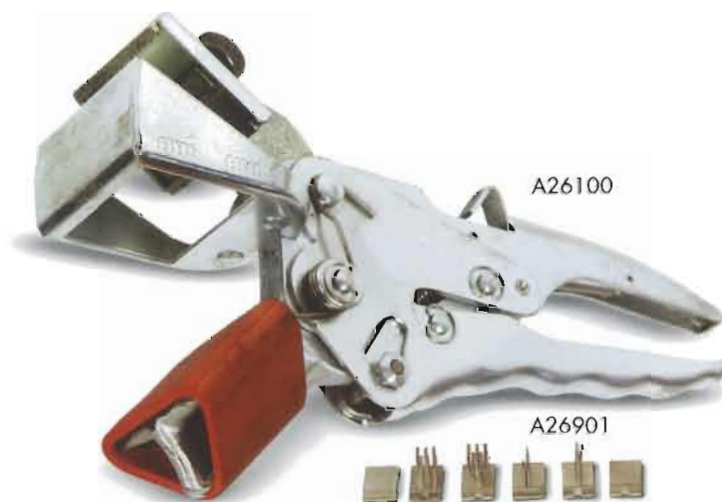

A26100

A26901

A2689V

A26910



A2610A	1 Pz.	Dado e Vite Esagonale
A2610B	1 Pz.	Gomma Tenaglia
A2610C	1 Pz.	Manico Mobile
A2610D	1 Pz.	Molla Congiunzione Manici
A2610E	1 Pz.	Molla Fissa Numeri
A2610F	1 Pz.	Molla Manico Fisso Esterna
A2610G	1 Pz.	Molla Manico Fisso Interna
A2610H	1 Pz.	Molla Principale
A2610L	1 Pz.	Perno Quadro Congiunzione Manici
A2610M	1 Pz.	Perno Superiore Grande
A2610N	1 Pz.	Perno Superiore Piccolo
A2610P	1 Pz.	Piastrina Copri Numeri
A2610Q	1 Pz.	Piastrina Esterna
A2610R	1 Pz.	Piastrina Fissa Numeri
A2610S	1 Pz.	Ribattino Tenaglia
A2610T	1 Pz.	Rondella Perno Superiore Grande
A2610U	1 Pz.	Sieger
A2610V	1 Pz.	Vite Fissa Numeri

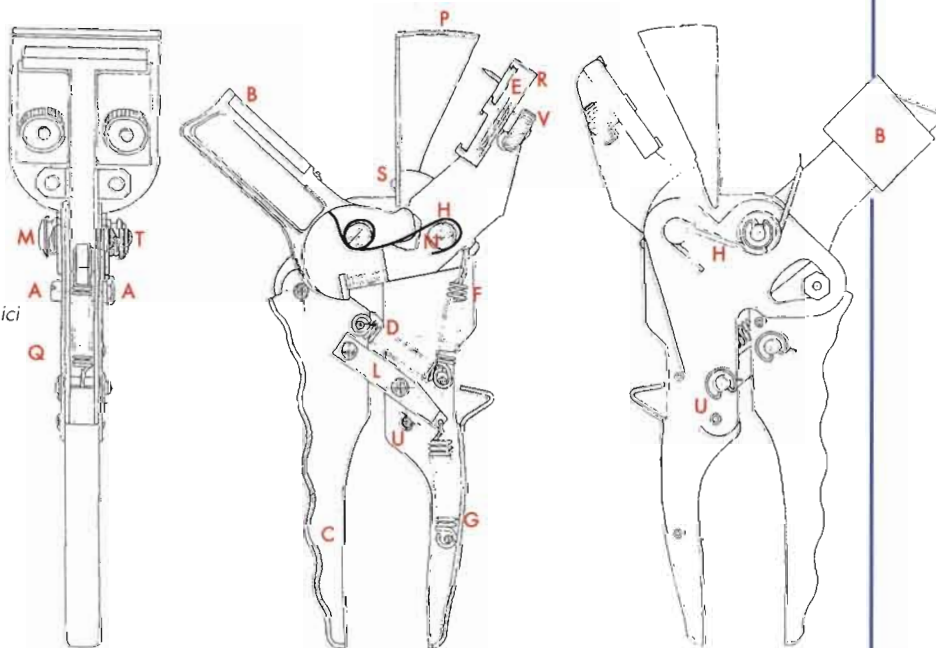



TENAGLIE TATUAGGIO



NAZIONALE 7 mm 7 SPAZI su una fila
 NAZIONALE 7 mm 10 SPAZI su una fila
Gomma
 NAZIONALE 7 mm 10 SPAZI su due file
Gomma
 TEDESCA 7 mm 8 SPAZI su una fila
 TEDESCA 7 mm 10 SPAZI su una fila
 TEDESCA 7 mm 10 SPAZI su due file

1 Pz. A26200
 1 Pz. A26210
 1 Pz. A2621A
 1 Pz. A26220
 1 Pz. A2622A
 1 Pz. A26400
 1 Pz. A26410
 1 Pz. A26420

A2621A



A26410



A26420

TENAGLIE TATUAGGIO



A26230

A2623A

A2623C

A2623D

A2623B

NAZIONALE 10 mm 8 SPAZI su una fila
Gomma
Piastrina Fissa Numeri
Vite Manico
Vite per Piastrina Fissa Numeri

1 Pz. A26230
 1 Pz. A2623A
 1 Pz. A2623B
 1 Pz. A2623C
 1 Pz. A2623D





Codice

Conf.

TENAGLIA TATUAGGIO

A26300

1 Pz.

ROTARY 10 mm 5 SPAZI su una fila

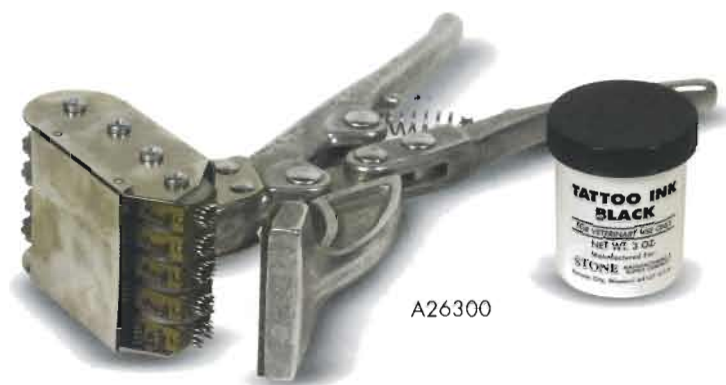

A26300



MARTELLETTO TATUAGGIO

A27000

1 Pz.

MARTELLETTO TATUAGGIO

A2701A/Z

1 Pz.

LETTERE MARTELLETTO TATUAGGIO

A27020/9

1 Pz.

NUMERO MARTELLETTO TATUAGGIO

A27030

10 Pz.

SERIE COMPLETA NUMERI PER MARTELLETTO TATUAGGIO

A27040

1 Pz.

SPAZIATORE MARTELLETTO TATUAGGIO



A27000

A27040

A2701T

A2702T



MARCHI

A28500

1 Pz.

PISTOLA PNEUMATICA PER PROSCIUTTI

A30000

9 Pz.

A FUOCO: serie completa numeri

A30010

9 Pz.

PER AZOTO: serie completa numeri



A30000

A30010





NUMERI E LETTERE TENAGLIA TATUAGGIO



Punta a Scalpello



Punta Normale

ESEMPIO ALTEZZA CIFRE

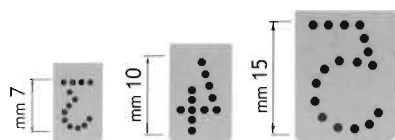

Scala 1:1

ESEMPIO COMPOSIZIONE TATUAGGI



7 spazi su 1 fila

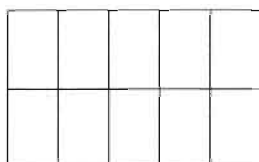

10 spazi su 2 fila

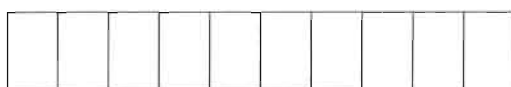

10 spazi su 1 fila



LETTERA DA 5mm	1 Pz.	A2670A,B..Z
NUMERO 5 mm	1 Pz.	A26710,1..9
SPAZIATORE 5 mm	1 Pz.	A26720
SERIE COMPLETA LETTERE DA 5 mm	26 Pz.	A26721
SERIE COMPLETA NUMERI DA 5 mm	10 Pz.	A26722
LETTERA DA 7 mm	1 Pz.	A2673A,B..Z
NUMERO 7 mm	1 Pz.	A26740,1..9
SPAZIATORE 7 mm	1 Pz.	A26750
SERIE COMPLETA LETTERE DA 7 mm	26 Pz.	A26751
SERIE COMPLETA NUMERI DA 7 mm	10 Pz.	A26752
LETTERA DA 10 mm	1 Pz.	A2676A,B..Z
NUMERO 10 mm	1 Pz.	A26770,1..9
SPAZIATORE 10 mm	1 Pz.	A26780
SERIE COMPLETA LETTERE DA 10 mm	26 Pz.	A26781
SERIE COMPLETA NUMERI DA 10 mm	10 Pz.	A26782
SERIE COMPLETA LETTERE DA 10 mm BASE IN PLASTICA	26 Pz.	A26790
SERIE COMPLETA NUMERI DA 10 mm BASE IN PLASTICA	10 Pz.	A26791
LETTERA DA 10 mm A SCALPELLO	1 Pz.	A2680A,B..Z
NUMERO 10 mm A SCALPELLO	1 Pz.	A26810,1..9
SERIE COMPLETA LETTERE DA 10 mm A SCALPELLO	26 Pz.	A26820
SERIE COMPLETA NUMERI DA 10 mm A SCALPELLO	10 Pz.	A26821
SERIE COMPLETA NUMERI DA 10 mm A SCALPELLO HAUPTNER	10 Pz.	A26825
SERIE COMPLETA LETTERE DA 10 mm A SCALPELLO HAUPTNER	26 Pz.	A26826
LETTERA DA 15 mm	1 Pz.	A2683A,B..Z
NUMERO 15 mm	1 Pz.	A26840,1..9
SPAZIATORE 15 mm	1 Pz.	A26850
SERIE COMPLETA LETTERE DA 15 mm	26 Pz.	A26851
SERIE COMPLETA NUMERI DA 15 mm	10 Pz.	A26852
LETTERA DA 20 mm	1 Pz.	A2686A,B..Z
NUMERO 20 mm	1 Pz.	A26870,1..9
SPAZIATORE 20 mm	1 Pz.	A26880
SERIE COMPLETA LETTERE DA 20 mm	26 Pz.	A26881
SERIE COMPLETA NUMERI DA 20 mm	10 Pz.	A26882
LETTERA HORSTMANN	1 Pz.	A2689A,B..Z
NUMERO HORSTMANN	1 Pz.	A26900,1..9
SPAZIATORE HORSTMANN	1 Pz.	A26910
SERIE COMPLETA LETTERE HORSTMANN	26 Pz.	A26911
SERIE COMPLETA NUMERI HORSTMANN	10 Pz.	A26912
LETTERA DA mm 10 HAUPTNER	1 Pz.	A2800A,B..Z
NUMERO mm 10 HAUPTNER	1 Pz.	A28010,1..9



Codice	Conf.		
A40200 A40300	1 Pz. 1 Pz.	<p>SPRAY COLORATO PORCIMARK</p> <p>200 cc 400 cc</p> <p>COLORI DISPONIBILI: Verde/Rosso/Blu</p>	<p>A40300 (Red can)</p> <p>A40200 (Blue and Green cans)</p>
A40400 A40500	1 Pz. 1 Pz.	<p>SPRAY COLORATO RAIDEX</p> <p>200 cc 400 cc</p> <p>COLORI DISPONIBILI: Verde/Rosso/Blu</p>	<p>A40400 (Red cans)</p> <p>A40500 (Green and Blue cans)</p>
A40600 A40650	1 Pz. 1 Pz.	<p>SPRAY COLORATO EUROFARM</p> <p>200 cc 400 cc</p> <p>COLORI DISPONIBILI: Verde/Rosso/Blu</p>	<p>A40600 (Blue can)</p> <p>A40650 (Red and Green cans)</p>

IDENTIFICAZIONE



Conf.

Codice



A50000

STICK RAIDL

METALLO

1 Pz.

A50000

COLORI DISPONIBILI:

Blu/Nero/Viola/Verde/Rosso

PLASTICA A VITE

1 Pz.

A51000

COLORI DISPONIBILI:

Blu/Nero/Viola/Verde/Rosso/Giallo



A51000

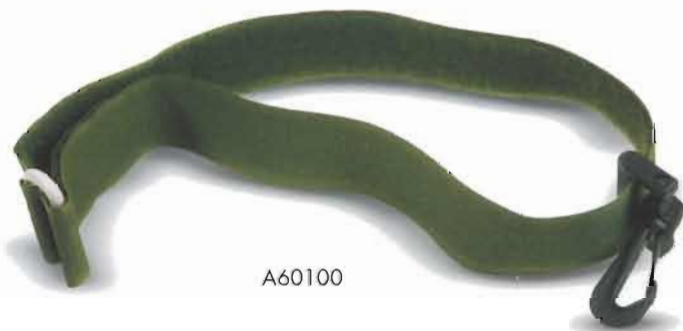

A60100



COLLARI

PER CAPRA A STRAPPO

1 Pz.

A60100



A60500

A60557



A60510

A60553



A60410

A60421



A60400



A60000

COLLARI

DA FIERA PER BOVINI

1 Pz.

A60000

PER TORO IN CUIO

1 Pz.

A60400

PER TORO IN NYLON

1 Pz.

A60410

PER TORO IN NYLON CON CATENA

1 Pz.

A60415

PER TORO IN NYLON GRANDE

1 Pz.

A60420

ANELLO COLLARE PER TORO

1 Pz.

A60421

GRANDE IN NYLON

COLLARE TIPO ALFA

1 Pz.

A60500

CON FIBBIA

COLLARE TIPO ALFA

1 Pz.

A60510

CON ANELLI

NUMERI PER COLLARI ALFA

1 Pz.

A60550/9



A60420





Codice

Conf.

COLLARI, MEDAGLIONI E MEDAGLIETTE

COLLARI:

- A60200 1 Pz. PER OVINI IN GOMMA BIANCO
- A60210 1 Pz. PER OVINI IN PLASTICA GRIGIO

MEDAGLIONI PER COLLARI:

- A70000 10 Pz. DEMAPLAST PICCOLO NUMERATO PLASTICA
 - A70010 10 Pz. DEMAPLAST GRANDE NUMERATO PLASTICA
- COLORI DISPONIBILI:
Arancio/Blu/Giallo/Rosso/Verde

- A70020 50 Pz. DEMAPLAST PICCOLO NON NUMERATO GOMMA

- A70030 50 Pz. DEMAPLAST GRANDE NON NUMERATO GOMMA
- COLORI DISPONIBILI:
Bianco/Giallo

- A71000 1 Pz. ECONOMICO GRANDE NUMERATO
 - A71010 1 Pz. ECONOMICO GRANDE NON NUMERATO
- COLORI DISPONIBILI:
Arancio/Bianco/Giallo/Rosso

- A72000 1 Pz. CATENA PER MEDAGLIONI
- A73000 1 Pz. ANELLO PIATTO PER CATENA

MEDAGLIETTA:

- A74000 100 Pz. PER OVINI NUMERATA
- A74100 100 Pz. PER OVINI NON NUMERATA



GAMBALI

- A80000 10 Pz. A STRAPPO
- COLORI DISPONIBILI:
Fucsio/Giallo/Verde/Rosso

- A80100 10 Pz. LABU-MARK
- COLORI DISPONIBILI:
Arancio/Giallo

- A80200 1 Pz. EUROFARM
- COLORI DISPONIBILI:
Giallo/Arancio/Rosso

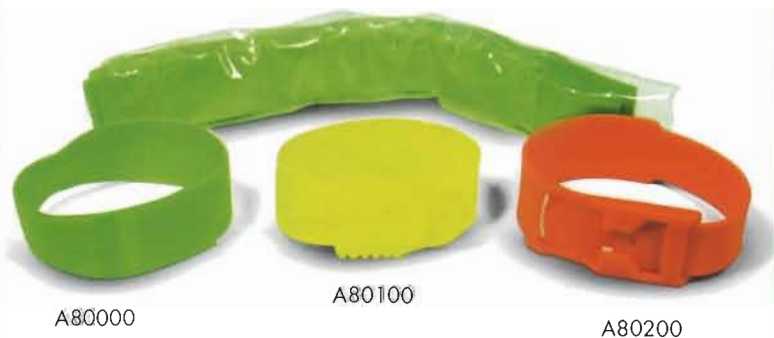



A90000

A90001/2..12

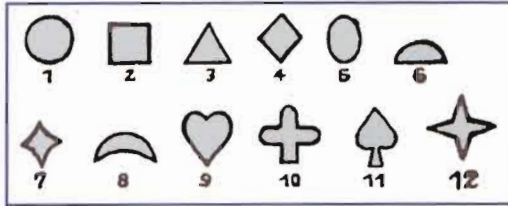

SEGNAORECCHIE

HERBERHOLZ

FIGURE PER SEGNAORECCHIE
HERBERHOLZ

Conf.

Codice

1 Pz.	A90000
1 Pz.	A90001
1 Pz.	A90002
1 Pz.	A90003
1 Pz.	A90004
1 Pz.	A90005
1 Pz.	A90006
1 Pz.	A90007
1 Pz.	A90008
1 Pz.	A90009
1 Pz.	A90010
1 Pz.	A90011
1 Pz.	A90012

SEGNAORECCHIE

NORDICO MOD. 1

NORDICO MOD. 2

NORDICO MOD. 3



A90100



A90101



A90102



1 Pz.	A90100
1 Pz.	A90101
1 Pz.	A90102

SEGNAORECCHIE

TONDO

TENAGLIA A T

FORBICI SEGNABESTIAME
NAZIONALI



A90200



A90300



A91000



1 Pz.	A90200
1 Pz.	A90300
1 Pz.	A91000