

• **CHIRURGIA** •





Codice

Conf.

FORBICI CHIRURGICHE NAZIONALI RETTE

| | | |
|--------|-------|---------------------|
| L10000 | 1 Pz. | PUNTA ACUTA cm 14 |
| L10001 | 1 Pz. | PUNTA ACUTA cm 16 |
| L10002 | 1 Pz. | PUNTA ACUTA cm 18 |
| L10003 | 1 Pz. | PUNTA SMUSSA cm 14 |
| L10004 | 1 Pz. | PUNTA SMUSSA cm 16 |
| L10005 | 1 Pz. | PUNTA SMUSSA cm 18 |
| L10006 | 1 Pz. | PUNTA ALTERNA cm 14 |
| L10007 | 1 Pz. | PUNTA ALTERNA cm 16 |
| L10008 | 1 Pz. | PUNTA ALTERNA cm 18 |



FORBICI CHIRURGICHE NAZIONALI CURVE

| | | |
|--------|-------|---------------------|
| L10010 | 1 Pz. | PUNTA ACUTA cm 14 |
| L10011 | 1 Pz. | PUNTA ACUTA cm 16 |
| L10012 | 1 Pz. | PUNTA ACUTA cm 18 |
| L10013 | 1 Pz. | PUNTA SMUSSA cm 14 |
| L10014 | 1 Pz. | PUNTA SMUSSA cm 16 |
| L10015 | 1 Pz. | PUNTA SMUSSA cm 18 |
| L10016 | 1 Pz. | PUNTA ALTERNA cm 14 |
| L10017 | 1 Pz. | PUNTA ALTERNA cm 16 |
| L10018 | 1 Pz. | PUNTA ALTERNA cm 18 |



FORBICI CHIRURGICHE TEDESCHE RETTE

| | | |
|--------|-------|---------------------|
| L10102 | 1 Pz. | PUNTA ACUTA cm 12 |
| L10100 | 1 Pz. | PUNTA ACUTA cm 14 |
| L10101 | 1 Pz. | PUNTA ACUTA cm 16 |
| L10105 | 1 Pz. | PUNTA SMUSSA cm 12 |
| L10103 | 1 Pz. | PUNTA SMUSSA cm 14 |
| L10104 | 1 Pz. | PUNTA SMUSSA cm 16 |
| L10108 | 1 Pz. | PUNTA ALTERNA cm 12 |
| L10106 | 1 Pz. | PUNTA ALTERNA cm 14 |
| L10107 | 1 Pz. | PUNTA ALTERNA cm 16 |





FORBICI CHIRURGICHE TEDESCHE CURVE



| | | |
|---------------------|-------|--------|
| PUNTA ACUTA cm 12 | 1 Pz. | L10112 |
| PUNTA ACUTA cm 14 | 1 Pz. | L10110 |
| PUNTA ACUTA cm 16 | 1 Pz. | L10111 |
| PUNTA SMUSSA cm 12 | 1 Pz. | L10115 |
| PUNTA SMUSSA cm 14 | 1 Pz. | L10113 |
| PUNTA SMUSSA cm 16 | 1 Pz. | L10114 |
| PUNTA ALTERNA cm 12 | 1 Pz. | L10118 |
| PUNTA ALTERNA cm 14 | 1 Pz. | L10116 |
| PUNTA ALTERNA cm 16 | 1 Pz. | L10117 |



FORBICI METZEMBAUM

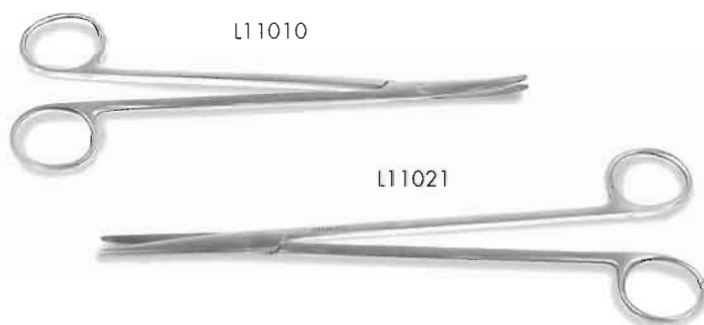

| | | |
|-------------|-------|--------|
| CURVE cm 18 | 1 Pz. | L11010 |
| CURVE cm 20 | 1 Pz. | L11011 |
| RETTE cm 18 | 1 Pz. | L11020 |
| RETTE cm 20 | 1 Pz. | L11021 |



FORBICI MAYO NAZIONALI

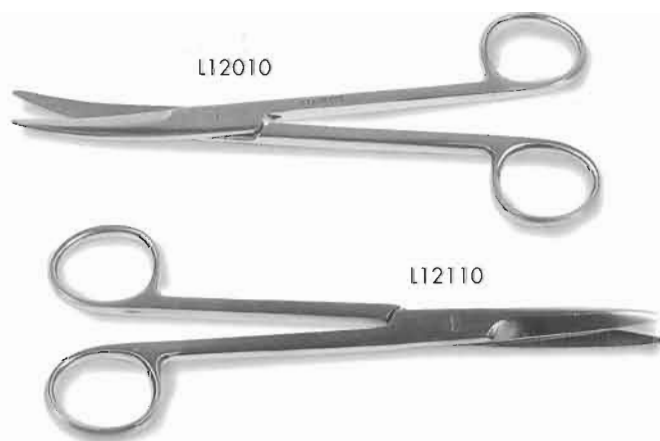

| | | |
|-------------|-------|--------|
| CURVE cm 18 | 1 Pz. | L12000 |
| CURVE cm 20 | 1 Pz. | L12010 |
| RETTE cm 16 | 1 Pz. | L12105 |
| RETTE cm 18 | 1 Pz. | L12100 |
| RETTE cm 20 | 1 Pz. | L12110 |



Codice

Conf.



FORBICI LEXER TEDESCHE

- L13000 1 Pz. RETTE cm 16
- L13002 1 Pz. RETTE cm 20
- L13010 1 Pz. CURVE cm 16



- ## FORBICI
- L16000 1 Pz. FORBICI PER BENDAGGIO
 - L16030 1 Pz. FORBICI TAGLIA GESSO



- ## FORBICI
- L16020 1 Pz. FORBICI TAGLIA PAIETTES
 - L16040 1 Pz. FORBICI BOTTONUTE
 - L18000 1 Pz. FODERO PER FORBICI





L20000



PINZE ANATOMICHE NAZIONALI

cm 14
cm 16
cm 18
cm 20
cm 24

1 Pz. L20000
1 Pz. L20001
1 Pz. L20002
1 Pz. L20003
1 Pz. L20004

TEDESCHE

cm 14
cm 16
cm 18
cm 20
cm 24

1 Pz. L20010
1 Pz. L20011
1 Pz. L20012
1 Pz. L20013
1 Pz. L20014



L20100

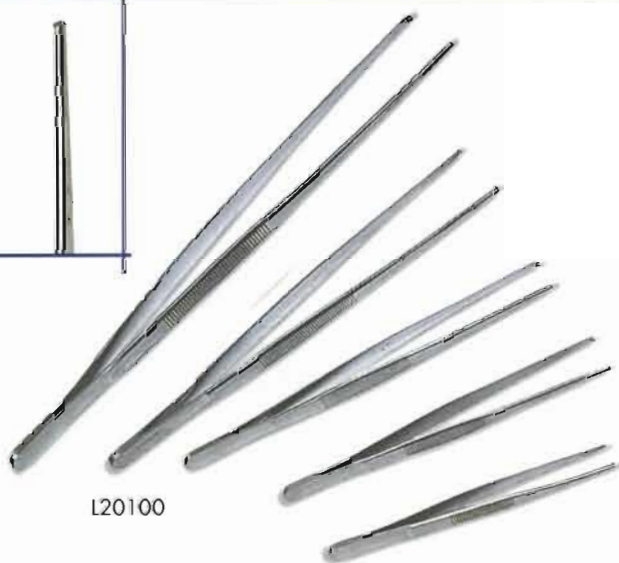

PINZE CHIRURGICHE NAZIONALI

cm 14
cm 16
cm 18
cm 20
cm 24

1 Pz. L20100
1 Pz. L20101
1 Pz. L20102
1 Pz. L20103
1 Pz. L20104

TEDESCHE

cm 14
cm 16
cm 18
cm 20
cm 24

1 Pz. L20110
1 Pz. L20111
1 Pz. L20112
1 Pz. L20113
1 Pz. L20114
1 Pz. L20130

cm 16 3x2 DENTINI

L20198



PINZE KLEMMER NAZIONALI

MOSQUITO CURVA cm 12

1 Pz. L20197

CURVA cm 12

1 Pz. L20199

CURVA cm 14

1 Pz. L20200

CURVA cm 16

1 Pz. L20201

CURVA cm 18

1 Pz. L20202

CURVA cm 20

1 Pz. L20203

CURVA cm 24

1 Pz. L20204

MOSQUITO RETTA cm 12

1 Pz. L20197

RETTA cm 12

1 Pz. L20198

RETTA cm 14

1 Pz. L20205

RETTA cm 16

1 Pz. L20206

RETTA cm 18

1 Pz. L20207

RETTA cm 20

1 Pz. L20208

RETTA cm 24

1 Pz. L20209

Codice

Conf.



PINZE KLEMMER TEDESCHE

| | | |
|--------|-------|----------------------|
| L20217 | 1 Pz. | MOSQUITO CURVA cm 10 |
| L20219 | 1 Pz. | MOSQUITO CURVA cm 12 |
| L20220 | 1 Pz. | CURVA cm14 |
| L20221 | 1 Pz. | CURVA cm 16 |
| L20222 | 1 Pz. | CURVA cm 18 |
| L20223 | 1 Pz. | CURVA cm 20 |
| L20224 | 1 Pz. | CURVA cm 24 |
| L20216 | 1 Pz. | MOSQUITO RETTA cm 10 |
| L20218 | 1 Pz. | MOSQUITO RETTA cm 12 |
| L20225 | 1 Pz. | RETTA cm 14 |
| L20226 | 1 Pz. | RETTA cm 16 |
| L20227 | 1 Pz. | RETTA cm 18 |
| L20228 | 1 Pz. | RETTA cm 20 |
| L20229 | 1 Pz. | RETTA cm 24 |



L20218

PINZE KOCHER NAZIONALI

| | | |
|--------|-------|----------------------|
| L20313 | 1 Pz. | MOSQUITO CURVA cm 12 |
| L20311 | 1 Pz. | CURVA cm 12 |
| L20300 | 1 Pz. | CURVA cm 14 |
| L20301 | 1 Pz. | CURVA cm 16 |
| L20302 | 1 Pz. | CURVA cm 18 |
| L20303 | 1 Pz. | CURVA cm 20 |
| L20304 | 1 Pz. | CURVA cm 24 |
| L20312 | 1 Pz. | MOSQUITO RETTA cm 12 |
| L20310 | 1 Pz. | RETTA cm 12 |
| L20305 | 1 Pz. | RETTA cm 14 |
| L20306 | 1 Pz. | RETTA cm 16 |
| L20307 | 1 Pz. | RETTA cm 18 |
| L20308 | 1 Pz. | RETTA cm 20 |

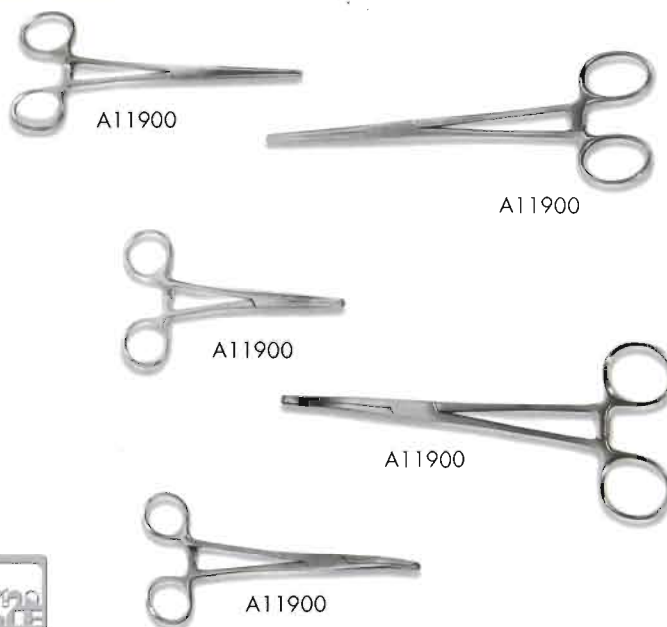

A11900

A11900

A11900

A11900

A11900

PINZE KOCHER TEDESCHE

| | | |
|--------|-------|----------------------|
| L20330 | 1 Pz. | MOSQUITO CURVA cm 10 |
| L20331 | 1 Pz. | MOSQUITO CURVA cm 12 |
| L20320 | 1 Pz. | CURVA cm14 |
| L20321 | 1 Pz. | CURVA cm 16 |
| L20322 | 1 Pz. | CURVA cm 18 |
| L20323 | 1 Pz. | CURVA cm 20 |
| L20324 | 1 Pz. | CURVA cm 24 |
| L20332 | 1 Pz. | MOSQUITO RETTA cm 10 |
| L20333 | 1 Pz. | MOSQUITO RETTA cm 12 |
| L20325 | 1 Pz. | RETTA cm 14 |
| L20326 | 1 Pz. | RETTA cm 16 |
| L20327 | 1 Pz. | RETTA cm 18 |
| L20328 | 1 Pz. | RETTA cm 20 |



L20320





PINZE HARTMANN

cm 8
cm 14

1 Pz. L20400
1 Pz. L20410



PINZE ALLIS

cm 15
cm 18

1 Pz. L20500
1 Pz. L20510



PINZE YOUNG

TEDESCA cm 20 1 Pz. L20600
 HAUPTNER cm 30 1 Pz. L20610
 Gomma per pinza young hauptner cm 30 (SET) 1 Pz. L2061A
 NAZIONALE cm 30 1 Pz. L20620
 Molla per pinza young nazionale cm 30 1 Pz. L2062A
 TIPO HAUPTNER cm 30 1 Pz. L20630
 Gomma per pinza young tipo hauptner cm 30 1 Pz. L2063A



Codice

Conf.



PINZE ENTEROSTATO

L20700

1 Pz.

CURVA cm 25

L20711

1 Pz.

RETTA cm 25

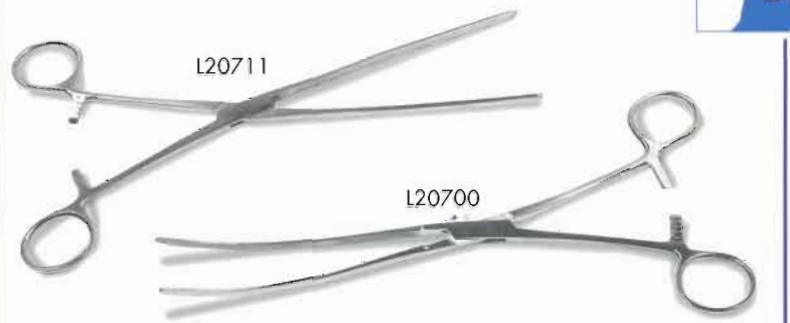

PINZE UTERINE

L20900

1 Pz.

cm 25

L20910

1 Pz.

MOD. 1

L20920

1 Pz.

MOD. 2

L20930

1 Pz.

MOD. 3

L20940

1 Pz.

MOD. 4

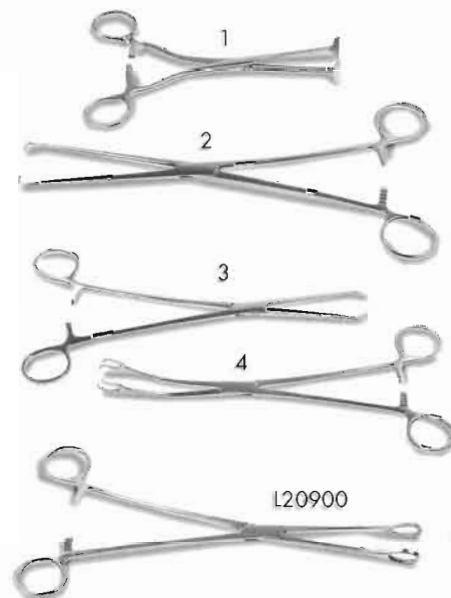

PINZE UTERINE

L21000

1 Pz.

DUVAL cm 20





L21100



L21110



L21300



PINZE

EMOSTATICHE

PEAN cm 15

PEAN cm 25

AURICOLARI

TROELTSCH cm 18

1 Pz.

L21100

1 Pz.

L21110

1 Pz.

L21300

PINZE DURANTE

NAZIONALE cm 16

TEDESCA cm 16

L21400



1 Pz.

L21400

1 Pz.

L21410

PINZA DOYEN

cm 20

L21500



1 Pz.

L21500

Codice

Conf.



PINZE CERVICALE

L21700

1 Pz.

cm 50

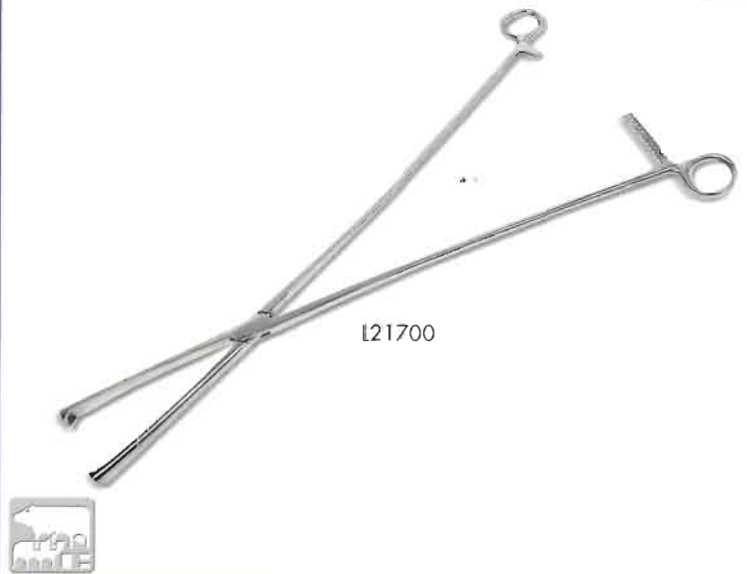

L21900

1 Pz.

PINZA CHIRON

L20050

1 Pz.

cm 12

PINZA ADSON



L22000

1 Pz.

PER PAIETTES

L22010

1 Pz.

TAGLIA PAIETTES

PINZE



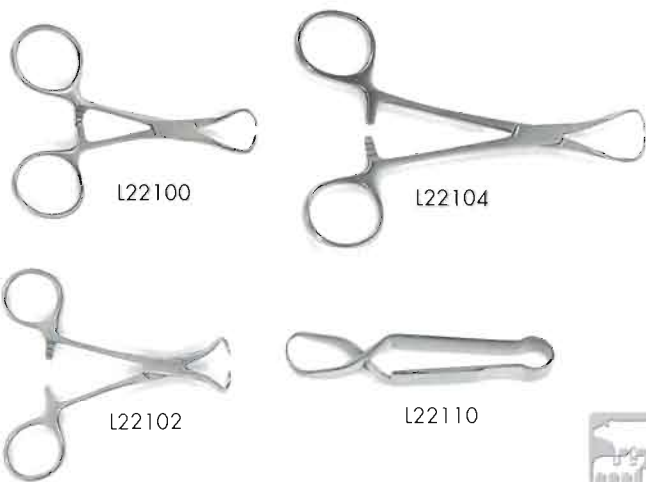

FISSATELI

| | | |
|----------------|-------|--------|
| BACKHAUS cm 8 | 1 Pz. | L22100 |
| BACKHAUS cm 10 | 1 Pz. | L22102 |
| BACKHAUS cm 13 | 1 Pz. | L22104 |
| SCHAEDEL cm 9 | 1 Pz. | L22110 |



PORT'AGHI MATHIEU



NAZIONALI

| | | |
|------------------|-------|--------|
| cm 14 | 1 Pz. | L30000 |
| cm 17 | 1 Pz. | L30010 |
| cm 20 | 1 Pz. | L30020 |
| TC cm 14 | 1 Pz. | L30100 |
| TC cm 17 | 1 Pz. | L30110 |
| TC cm 20 | 1 Pz. | L30120 |
| TC ROBUSTO cm 20 | 1 Pz. | L30130 |

TEDESCO

| | | |
|------------------|-------|--------|
| cm 14 | 1 Pz. | L30200 |
| Molla | 1 Pz. | L3020A |
| cm 17 | 1 Pz. | L30210 |
| Molla | 1 Pz. | L3021A |
| cm 20 | 1 Pz. | L30220 |
| Molla | 1 Pz. | L3022A |
| TC cm 14 | 1 Pz. | L30300 |
| Molla | 1 Pz. | L3030A |
| TC cm 17 | 1 Pz. | L30310 |
| Molla | 1 Pz. | L3031A |
| TC cm 20 | 1 Pz. | L30320 |
| Molla | 1 Pz. | L3032A |
| TC ROBUSTO cm 20 | 1 Pz. | L30330 |
| Molla | 1 Pz. | L3033A |

HAUPTNER

| | | |
|----------|-------|--------|
| TC cm 14 | 1 Pz. | L30600 |
| TC cm 17 | 1 Pz. | L30610 |
| TC cm 20 | 1 Pz. | L30620 |
| cm 14 | 1 Pz. | L30650 |
| cm 17 | 1 Pz. | L30660 |
| cm 20 | 1 Pz. | L30670 |





Codice

Conf.

PORT'AGHI MAYO HEGAR

NAZIONALE

L31000 1 Pz. cm 16
L31010 1 Pz. cm 18
L31020 1 Pz. cm 20

TEDESCO

L31100 1 Pz. cm 16
L31110 1 Pz. cm 18
L31120 1 Pz. cm 20
L31200 1 Pz. TC cm 16
L31210 1 Pz. TC cm 18
L31220 1 Pz. TC cm 20

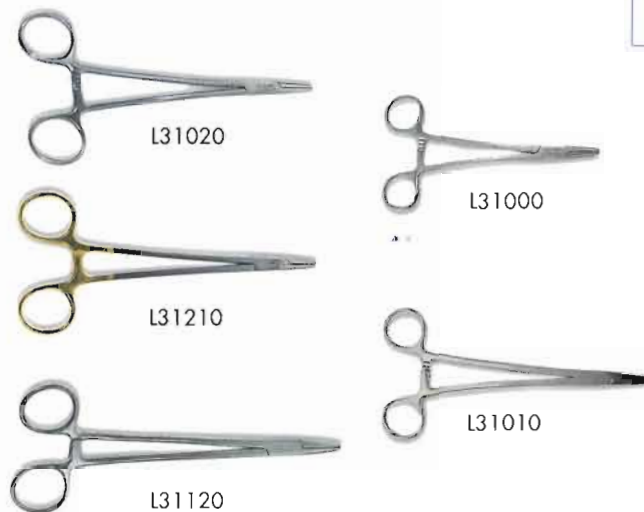

PORT'AGHI OLSEN HEGAR

NAZIONALE

L32000 1 Pz. cm 16
L32010 1 Pz. cm 18
L32020 1 Pz. cm 20

TEDESCO

L32100 1 Pz. cm 14
L32110 1 Pz. cm 16
L32120 1 Pz. cm 18
L32130 1 Pz. cm 20

HAUPTNER

L32200 1 Pz. TC cm 14

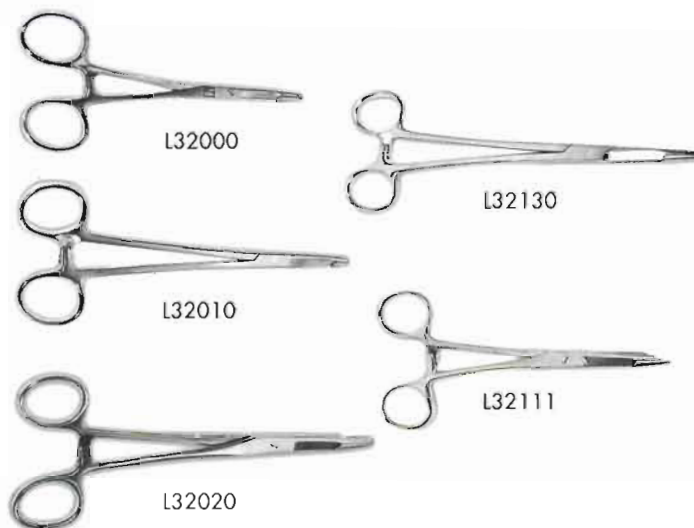

PORT'AGHI OLSEN MATHIEU

TEDESCO

L34000 1 Pz. TC cm 20
L34010 1 Pz. cm 20

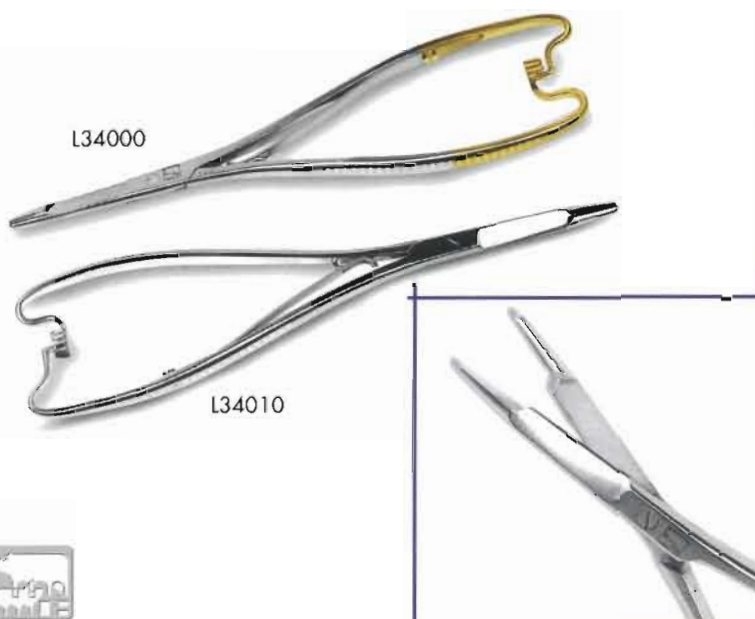



CHIODI DI KIRSCHNER

| | | |
|-----------------|-------|--------|
| DIAMETRO mm 1 | 1 Pz. | L40000 |
| DIAMETRO mm 1,2 | 1 Pz. | L40010 |
| DIAMETRO mm 1,5 | 1 Pz. | L40020 |
| DIAMETRO mm 1,8 | 1 Pz. | L40030 |
| DIAMETRO mm 2 | 1 Pz. | L40040 |
| DIAMETRO mm 2,5 | 1 Pz. | L40050 |
| DIAMETRO mm 3 | 1 Pz. | L40060 |

FILO PER OSSA

| | | |
|------------------------|-------|--------|
| DIAMETRO mm 0,4 x 10 m | 1 Pz. | L41000 |
| DIAMETRO mm 0,5 x 10 m | 1 Pz. | L41100 |
| DIAMETRO mm 0,6 x 10 m | 1 Pz. | L41200 |
| DIAMETRO mm 0,7 x 10 m | 1 Pz. | L41300 |
| DIAMETRO mm 0,8 x 10 m | 1 Pz. | L41400 |
| DIAMETRO mm 0,9 x 10 m | 1 Pz. | L41500 |
| DIAMETRO mm 1 x 10 m | 1 Pz. | L41600 |



L42100

MARTELLETTO PLESSIMETRO

| | | |
|--------------------------------|-------|--------|
| NAZIONALE | 1 Pz. | L42000 |
| HAUPTNER MOD. 510 | 1 Pz. | L42100 |
| HAUPTNER MANICO LEGNO MOD. 540 | 1 Pz. | L42110 |



L42110



STRUMENTI VARI

| | | |
|--------------------------------|-------|--------|
| SPICILLO | 1 Pz. | L50000 |
| SONDA SCANALATA cm 20 | 1 Pz. | L50100 |
| SONDA SCANALATA cm 13 | 1 Pz. | L50110 |
| CUCCHIAIO DI WOLKMANN MANICATO | 1 Pz. | L50200 |
| CUCCHIAIO DI WOLKMANN DOPPIO | 1 Pz. | L50210 |





Codice

Conf.

STRUMENTI VARI

| | | |
|--------|-------|------------------------------|
| L50400 | 1 Pz. | TRACHEOTUBO DI PAPE HAUPTNER |
| L50410 | 1 Pz. | TRACHEOTUBO ECONOMICO |
| L50500 | 1 Pz. | BLEFAROSTATO |
| L50600 | 1 Pz. | PASSALACCI DI SAND HAUPTNER |
| L50610 | 1 Pz. | PASSALACCI DI SAND LEGGERO |
| L50620 | 1 Pz. | PASSALACCI DI SAND PESANTE |

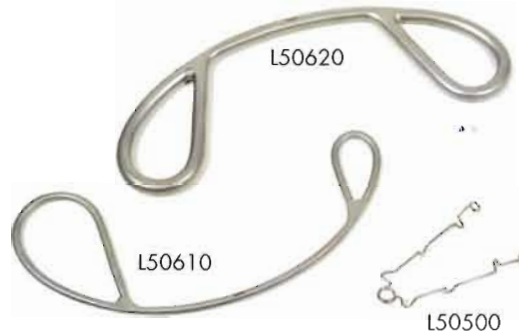

L50410



SACCHE PER RACCOLTA E TRASFUSIONE SANGUE

| | | |
|--------|--------|---|
| L60000 | 10 Pz. | Con CPDA-1 da ml 450 sterile ed apirogena |
|--------|--------|---|



L60000



| | |
|--------|-------|
| L70000 | 1 Pz. |
|--------|-------|

TAVOLO DA VISITA

Completamente in acciaio INOX.
 Provvisto di ganci lungo il perimetro del pianale. Inclinato e scanalato al centro con bacinella nella parte inferiore per facilitare il recupero dei liquidi e la pulizia.
 Larghezza 56 x 113 cm
 Altezza 87 cm



L70000





L70100

TAVOLO PNEUMATICO OPERATORIO

1 Pz.

L70100

Adatto per veterinaria. Costituito da una base in lamiera stampata a forte spessore, corredata da appositi livellatori per correggere eventuali dislivelli del pavimento. La robusta colonna di sostegno del piano è con attacco a bilanciere per permettere l'inclinazione sui due lati.

E' diviso in 2 sezioni di acciaio INOX che possono essere alzate ed aperte a libro con bloccaggio nella posizione voluta. Sotto il piano è predisposto un canale di raccolta liquidi e sangue, sfilabile per la pulizia. Larghezza cm 120x60. Altezza max cm 115. Portata max Kg 90



L70200

TAVOLINO SERVITORE

1 Pz.

70200

Vassoio in acciaio INOX, rimuovibile, regolabile in altezza, completo di rotelle per agevolare gli spostamenti.

Altezza regolabile da 80 a 115 cm.

Dimensioni piano cm 170 x 45 x 3h



L70301



BACINELLE PORTASTRUMENTI IN INOX

RENIFORME cm 20

1 Pz.

L70300

RENIFORME cm 25

1 Pz.

L70301

RETTANGOLARE cm 31,5 x 20 x 6

1 Pz.

L70310



L70310





Codice

Conf.

BOLLITORI A FIAMMA VIVA

PER STERILIZZARE GLI STRUMENTI
Completamente in acciaio INOX

| | | |
|--------|-------|----------------------------|
| L70600 | 1 Pz. | cm 20 x 10 |
| L70610 | 1 Pz. | cm 22 x 12 |
| L70620 | 1 Pz. | cm 25 x 12 |
| L70630 | 1 Pz. | cm 28 x 14 |
| L70640 | 1 Pz. | cm 32 x 15 |
| L70650 | 1 Pz. | cm 36 x 16 |
| L70660 | 1 Pz. | cm 40 x 16 |
| L70670 | 1 Pz. | cm 42 x 18 |
| L70680 | 1 Pz. | cm 50 x 20 |
| L70900 | 1 Pz. | PER STERILIZZARE ROCCHETTO |



L71000

1 Pz.

CARRELLO PORTA STRUMENTI

Costruito completamente in acciaio
INOX.

Due ripiani, maniglia per spinta.

Dimensioni: 60 x 40 x 80h



L71100

1 Pz.

PER TAVOLO OPERATORIO

Dimensioni: 50 x 100

L71110

1 Pz.

POMPA PER CUSCINO

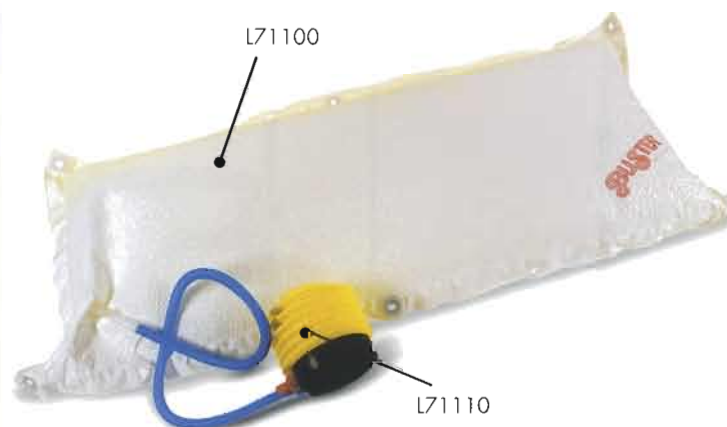



L71300



LAMPADA FRONTALE ALOGENA

1 Pz.

L71300



L71400

LAMPADA SCIALITICA A UN FARO

1 Pz.

L71400



L71500



L71510

PORTAFLEBO

PIANTANA

1 Pz.

L71500

PORTA FLACONE

1 Pz.

L71510



Codice

Conf.



ASPIRATORE ASKIR

L71600

1 Pz.

Aspiratore portatile elettrico, in ABS anti-urto, particolarmente adatto per spostamenti in corsia, tracheotomizzati e piccola chirurgia.

Alimentazione: 220V

Potenza assorbita: 90W

Dimensioni: 31 x 18 x 28 cm

Peso: 4,5 Kg

L71600



BUSTA PORTAFERRI

L71700

1 Pz.

IN PELLE

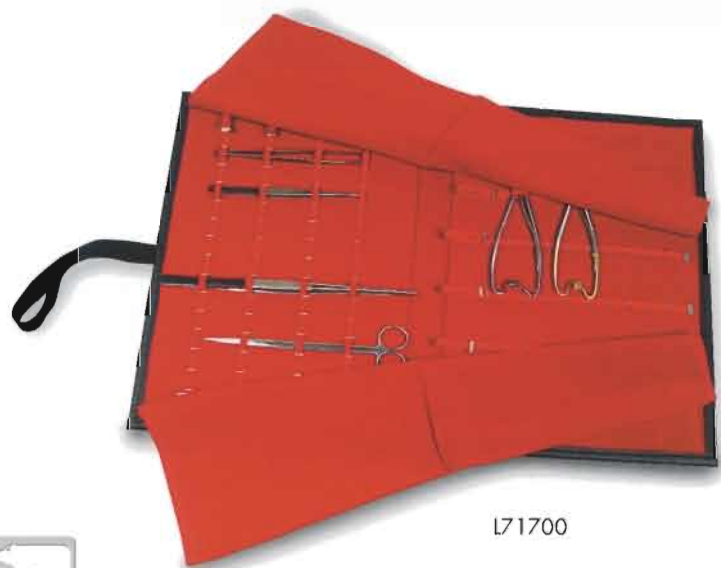

L71700

VASO PORTA COTONE

L71800

1 Pz.

Blu



L71800





TELI STERILI

| | | |
|------------|-------|--------|
| cm 30x45 | 1 Pz. | L80000 |
| cm 60x90 | 1 Pz. | L80100 |
| cm 90x120 | 1 Pz. | L80200 |
| cm 120x120 | 1 Pz. | L80300 |
| cm 120x180 | 1 Pz. | L80400 |
| cm 120x250 | 1 Pz. | L80500 |

GUANTI CHIRURGICI STERILI

| | | |
|----------|--------|--------|
| ART SANA | 1 Paio | E20000 |
| BAXTER | 1 Paio | E20100 |

L80000

